



MICRO GROW

GREENHOUSE SYSTEMS, INC

26111 YNEZ RD., SUITE C-4, TEMECULA, CA 92591 PHONE (909)-296-3340 FAX (909)-296-3350

Revision 1.0 11-14-01

Fog System Growstat Control System

INSTALLATION PROCEDURES

GROWSTAT SERIES OF CONTROLLERS

PANEL MOUNTING

Mount the control panel in an accessible location. Make sure that the location is free of vibration and in close proximity to the devices being controlled. Always consider voltage drop of electrical current when locating the control panel. Securely mount the panel.

SWITCHING CONTACTORS AND RELAYS

The control panel will operate the greenhouse equipment via load contactors and load relays. **ALL RELAYS AND LOAD CONTACTORS USED MUST HAVE A SURGE SUPPRESSOR INSTALLED ACROSS THE COIL OF THE RELAY OR LOAD CONTACTOR.** These surge suppressors are readily available from Micro Grow Greenhouse Systems, Inc. All load contactors and relays are also readily available from Micro Grow Greenhouse Systems, Inc. To decide which to use, follow this guide:

LOAD CONTACTORS:

Exhaust fans, pad pumps, horizontal air flow fans, heating pumps, fan jets, large heaters, crop lighting, and all other larger electrical loads over 1/6 H.P.

LOAD RELAYS:

Signal switching such as the small control lines for gas fired heaters, control lines for vent and shade system controls, small loads such as motorized shutters, other loads up to 1/6 H.P.

CUSTOM CONTACTOR AND RELAY PANEL AVAILABLE

A UL, custom pre-wired load contactor and load relay panel is available from Micro Grow Greenhouse Systems, Inc. This panel will contain all of the required switching apparatus for your project, as well as a correctly sized machine tool transformer. Contact Micro Grow Greenhouse Systems, Inc for pricing and availability.

TRANSFORMERS

The control panel is to be powered by a 24 VAC transformer. It is most important to use a MACHINE TOOL TYPE. A Machine Tool Transformer is a heavy-duty variety that will allow for high inrush currents that are associated with the use of load contactors and relays. Micro Grow Greenhouse Systems, Inc. stocks this type of transformer. Use no smaller than a 40 VA Machine Tool Transformer.

ELECTRICAL CIRCUITS

The electrical circuit that feeds the machine tool transformer must have no other loads connected to it. This will prevent a damaging surge from other related electrical devices. Follow all local and national codes in the connection of all of the greenhouse equipment. Always allow for voltage drop conditions. Always consider that the greenhouse is a wet environment. Always follow the code rulings for disconnect switches and overcurrent devices on greenhouse equipment. **USE A QUALIFIED AND LICENSED ELECTRICIAN AT ALL TIMES.**

WIRING METHODS

Always use stranded wire when connecting cables or conductors to the actual circuit board of the control panel. This will allow flexibility. Use no smaller than #18 gauge, stranded wire for all outputs. Use no smaller than the recommended wire size of stranded cable for inputs; generally #22 gauge.

SENSOR CONDUCTORS:

Route sensor conductors separately from control conductors. This is very important so as to reduce electrical interference. Never route sensor conductors in conduits used for other voltages. This is in violation of the electrical code and will cause dangerous interference to the control system. Always locate the actual sensor in the center of the range that is being controlled for accurate readings. Do not allow the sensor to come in contact with any greenhouse structure member such as a post that would give off any radiated heat and cause a false temperature reading. Do not locate the sensor where a particular piece of equipment would cause false readings, such as a heater blowing directly on the sensor. Mount all wind/rain sensor in a clear area, free of any wind obstructions.

CONTROL CONDUCTORS:

Route all control conductors separately from sensor conductors. This is very important so as to reduce electrical interference. Control conductors may be routed in conduits that contain other power system wiring only if the insulation material on the conductors is the same as the power system wiring. Consult the national electrical code or local codes if in doubt about the insulation ratings of the wire in use. Remember; always use a qualified and licensed electrician.

VENT SYSTEMS, ROLL UP CURTAINS

When connecting a vent system, or roll up curtain ventilation system to the control panel, you must use a separate control box designed for that particular vent system. These are readily available from Micro Grow Greenhouse Systems, Inc. Generally these separate control boxes feature overcurrent protection for the particular motor on the vent or shade system, provisions for direct limit switch connections, and a manual means of operating the vent system independent of the main control system. These separate control boxes will connect the main control system either directly through the outputs of the control system, or they will require control relays for interconnection to the main control system. Consult the individual instructions that come with the vent or shade controls for detailed information.

SYSTEM TESTING

It is always important to completely and fully test the electrical system by energizing circuits and verifying equipment operations before automatically operating the equipment from the control panel. This would include setting all of the vent limit switches at the individual control panels.

Micro Grow Greenhouse Systems, Inc.

Fog System Growstat

Set Temperature and Humidity:

1. Depress the **SET** switch once. The **TEMPERATURE** indicator will be on. Use the **VALUE** switch to set the correct desired temperature. This will be the day mode temperature. Depress the **SET** switch again to light the **NIGHT** indicator along with the **TEMPERATURE** indicator. Set the desired night level here.
2. Depress the **SET** switch again. The **HUMIDITY** indicator will be on. Use the **VALUE** switch to set the correct desired humidity. Repeat for the night mode as in the above.
3. Return to the run mode by toggling the **RUN** switch up.

To Check High and Low History:

The control will automatically track the high and low readings for the past 24 hours for both inputs. To check them, depress the **SET** switch until the word "**HIGH**" appears in the display. The control will automatically indicate the highest reading for the past 24 hours. Depress the **SET** switch until the word "**LO**" appears in the display. The control will automatically indicate the highest reading for the past 24 hours. If you would like to reset these values, depress **VALUE** switch once while the system is in the high and low mode. The system will however automatically update these readings continuously.

To Set the Clock:

1. Continue to depress the **SET** switch until the **SET TIME** indicator is on. The item to be set will be flashing. Use the **VALUE** switch to raise or lower the flashing value. The first value will be hours. Depress the **SET** switch again to set the minutes, and once more to set if it is AM or PM.

To Set the Day and Night Mode Times:

The control can detect night automatically with the use of an external photocell. If no photocell is connected, it will use the internal 24 hour time clock. You can also use a combination of both if desired.

1. Continue to depress the **SET** switch until the **SET DAY MODE** indicator is on. If a photocell is connected to the system, adjust the hours setting till the word "**PHO**" appears in the display. If a photocell is not connected, a time can be set. Use the **VALUE** switch to change the setting.
2. Depress the **SET** switch again and repeat the above procedure to **SET NIGHT MODE**. If you do not want the NIGHT mode to be used, adjust the hours setting till "**OFF**" appears in the display.

To Calibrate the Control:

The control can be calibrated easily. Calibration is best performed in the early or late hours to prevent the interaction of the solar influence. Using a good mercury or digital thermometer and hydrometer, obtain the value to calibrate the control to.

1. Continue to depress the **SET** switch until the **CALIB** is on the display. The first number to appear afterwards is the temperature. Use the **VALUE** switch to change the setting.
2. Depress the **SET** switch again and repeat the above procedure to set the humidity reading. Return to the run mode when finished.

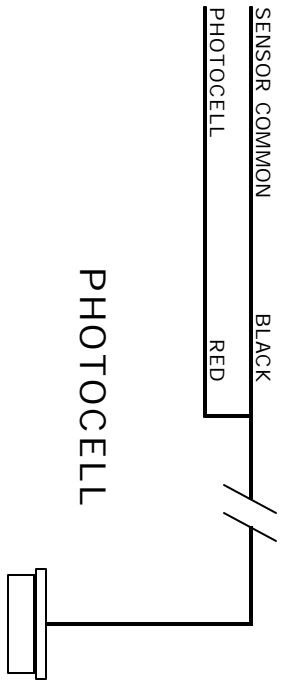

TO SENSOR
TERMINAL
STRIP

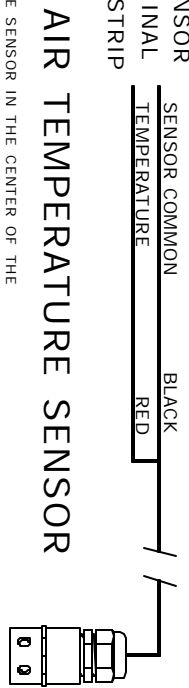

LOCATE SENSOR IN THE CENTER OF THE
CONTROLLED AREA, AT BENCH OR CROP LEVEL,
AWAY FROM DIRECT CONTACT WITH
GREENHOUSE METAL POSTS AND MEMBERS.

AIR TEMPERATURE SENSOR



AIR TEMPERATURE & HUMIDITY SENSOR

LOCATE SENSOR IN THE CENTER OF THE
CONTROLLED AREA, AT BENCH OR CROP LEVEL,
AWAY FROM DIRECT CONTACT WITH
GREENHOUSE METAL POSTS AND MEMBERS.



HUMIDITY SENSOR

LOCATE SENSOR IN THE CENTER OF THE
CONTROLLED AREA, AT BENCH OR CROP LEVEL,
AWAY FROM DIRECT CONTACT WITH
GREENHOUSE METAL POSTS AND MEMBERS.

FOG SYSTEM GROWSTAT SENSORS



MICRO GROW GREENHOUSE SYSTEMS, INC.
26111 Ynez Road, Suite C-4
Temecula, CA 92591
Phone 909.296.3340 Fax 909.296.3350

Project FOG SYSTEM GROWSTAT SENSORS			
Drawn by G H	Date 11/13/01	Distributor N/A	Order ID N/A

ASPIRATED HUMIDITY SENSOR

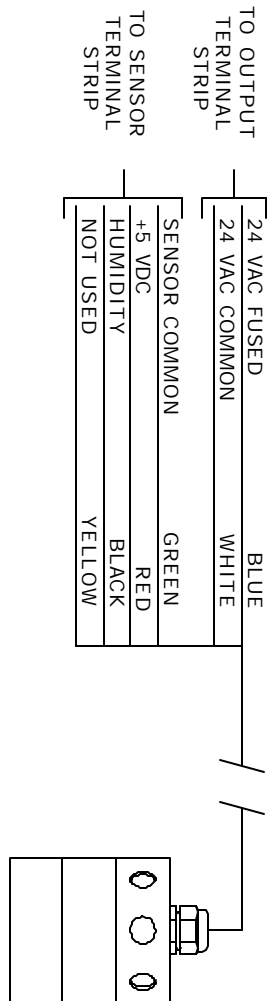

LOCATE SENSOR IN THE CENTER OF THE CONTROLLED AREA, AT BENCH OR CROP LEVEL, AWAY FROM DIRECT CONTACT WITH GREENHOUSE METAL POSTS AND MEMBERS.

ASPIRATED TEMPERATURE AND HUMIDITY SENSOR

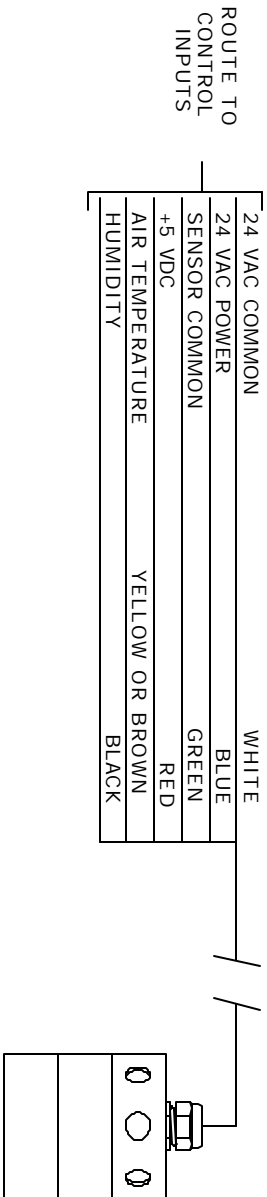

LOCATE SENSOR IN THE CENTER OF THE CONTROLLED AREA, AT BENCH OR CROP LEVEL, AWAY FROM DIRECT CONTACT WITH GREENHOUSE METAL POSTS AND MEMBERS.

FOG SYSTEM GROWSTAT SENSORS

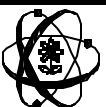

MICRO GROW GREENHOUSE SYSTEMS, INC.
 26111 Ynez Road, Suite C-4
 Temecula, CA 92591
 Phone 909.296.3340 Fax 909.296.3350

Project			
FOG SYSTEM GROWSTAT SENSORS - ASPIRATED			
Drawn by	Date	Distributor	Order ID
G H	11/13/01	N/A	N/A

OUTPUT NOTE:
 THE CONTROL OUTPUTS ARE RATED AT 1 AMP @24 VAC EACH MAXIMUM. DO NOT EXCEED THIS OR DAMAGE MAY RESULT. DO NOT EXCEED 1 AMP @24 VAC FOR ANY SINGLE OUTPUT.

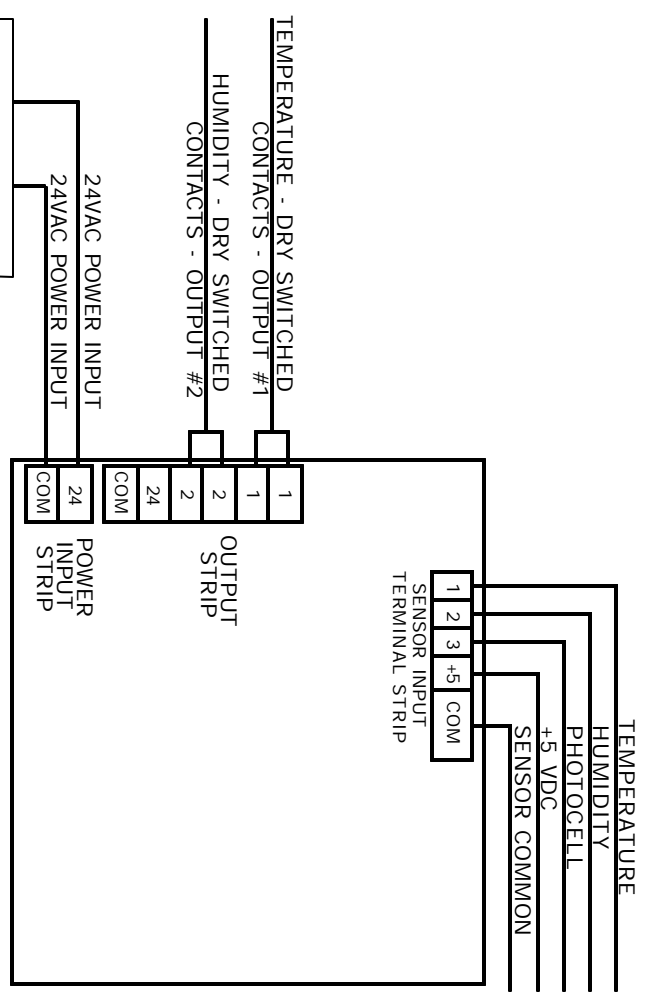

** - PULSE FOGGING CAN BE SET OR FLOATING. WHEN FLOATING IS CHOSEN, THE ACTUAL ON AND OFF TIMES WILL VARY FROM THE SELECTED TIMES ON THE SWITCHES 9 AND 10 ACCORDING TO THE HUMIDITY LEVEL AND SETPOINT.

FOG SYSTEM GROWSTAT INPUTS AND OUTPUTS

DIP SWITCH SETTINGS

TEMPERATURE MODE	
#1 OFF	FAHRENHEIT
#1 ON	CENTIGRADE
PHOTOCELL	
#2 ON	PHOTOCELL IN USE
#2 OFF	NO PHOTOCELL
TEMPERATURE DIFFERENTIAL	
#3 OFF #4 OFF	1 DEGREE
#3 ON #4 OFF	2 DEGREES
#3 OFF #4 ON	3 DEGREES
#3 ON #4 ON	4 DEGREES
HUMIDITY DIFFERENTIAL	
#5 OFF #6 OFF	2% RH
#5 ON #6 OFF	4% RH
#5 OFF #6 ON	6% RH
#5 ON #6 ON	8% RH
TIME DELAY	
#7 OFF	2 SECONDS
#7 ON	30 SECONDS
PULSE FOG **	
#8 OFF	SET
#8 ON	FLOAT
PULSING TIMES	
#9 OFF #10 OFF	MAINTAINED OUTPUT
#9 ON #10 OFF	15 SEC ON, 105 SEC OFF
#9 OFF #10 ON	30 SEC ON, 90 SEC OFF
#9 ON #10 ON	45 SEC ON, 75 SEC OFF
OUTPUT #1 DEFINITION	
#11 OFF	FOGGING
#11 ON	COOLING
OUTPUT #2 DEFINITION	
#12 OFF	FOGGING
#12 ON	COOLING

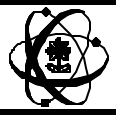

MICRO GROW GREENHOUSE SYSTEMS, INC.
 26111 Ynez Road, Suite C-4
 Temecula, CA 92591
 Phone 909.296.3340 Fax 909.296.3350

Project FOG SYSTEM GROWSTAT INPUT AND OUTPUTS			
Drawn by GH	Date 11/13/01	Distributor N/A	Order ID N/A

LIMITED WARRANTY

Micro Grow Greenhouse Systems, Inc. warrants that all of the products Micro Grow Greenhouse Systems, Inc. manufactures are free from defects at the time of shipment by Micro Grow Greenhouse Systems, Inc. This warranty covers defects in workmanship and materials. No warranty is extended on any parts, materials, or components manufactured by others and purchased by Micro Grow Greenhouse Systems, Inc., and any warranty on these materials is limited to the warranty supplied by the original manufacturer or supplier of said products only. This warranty excludes any and all damages cause by installation by unqualified individuals, damage by misuse or neglect, shipment damage, alterations to original manufacturing, and improper installation or use for any reason than intended by manufacturer. This warranty may not be altered in any manner except with the written authorization of one the officers or owners of Micro Grow Greenhouse Systems, Inc. The only and sole liability of Micro Grow Greenhouse Systems, Inc. under this warranty is limited to repairing, replacing or the issuance of credit for any products returned to Micro Grow Greenhouse Systems, Inc., during the warranty period of twelve (12) months from date of shipment. This warranty is specifically conditioned upon Micro Grow Greenhouse Systems, Inc. being notified in writing promptly upon discovery of any product defects by the buyer or end user. The product must then be returned prepaid to Micro Grow Greenhouse Systems, Inc. within the twelve month warranty period for inspection by Micro Grow Greenhouse Systems, Inc. Upon inspection of said product, Micro Grow Greenhouse Systems, Inc. will notify buyer or end user of its findings. At Micro Grow Greenhouse Systems, Inc. sole discretion, the product will be replaced, repaired or a credit will be issued for the original sale price of the product, provided that damage has not occurred due to misuse, neglect, improper use or installation as outlined above, shipping damages or accident.

MICRO GROW GREENHOUSE SYSTEMS, INC. SHALL NOT BE LIABLE FOR ANY DAMAGES BEYOND THE ACTUAL ORIGINAL COST OF THEIR PRODUCT EITHER DIRECTLY OR INDIRECTLY ARISING FROM DEFECTIVE PRODUCTS OR WORKMANSHIP.